

STERILE PROCESSING CONTAINERS AND BRUSHES



SECTION Y



Trays, brushes and accessories to aid in cleaning, protection and transport of instruments.

CONTENTS

Sterilization Trays/Containers	1-2
Cleaning Brushes	4-5
Instrument Trays	6-7
Mixing Solution Bowls	8
Medicine and Iodine Cups	8
Instrument Stringers	9
Instrument Identification	10
Instrument Protectors	11
Mesh Baskets	12
Debridement Pan	13

ORTHO+MED
The Surgical Instrument Specialists

Micro Tray with silicone cushion on the top and spiked silicone strips on the bottom, hold instruments gently yet snugly in place.

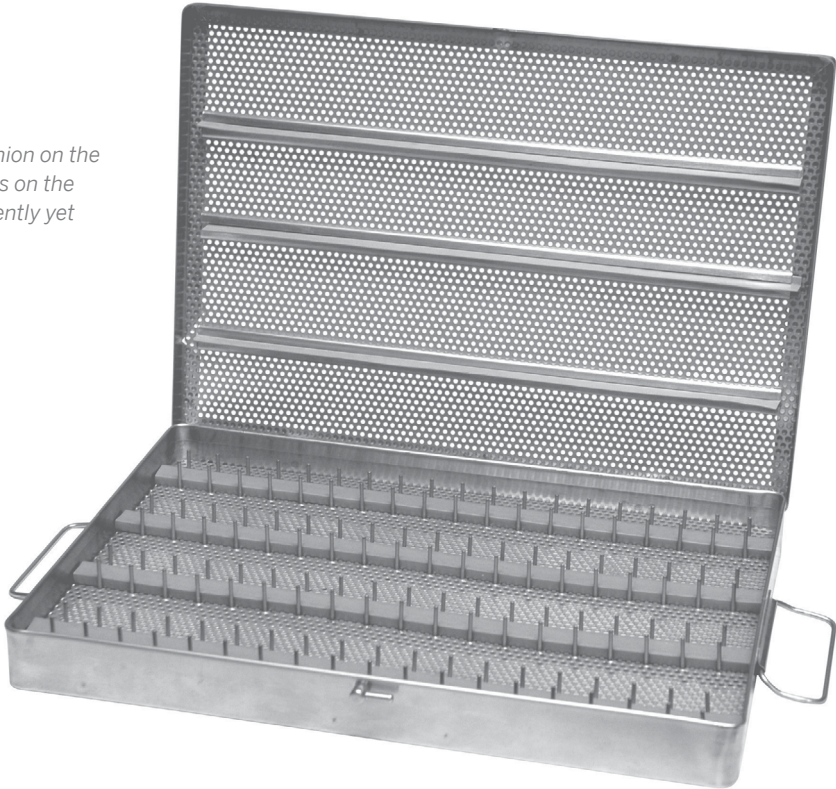

MICRO TRAY

With silicone mat strips

OM 81-0195	8 1/2" w x 8" l x 1 1/8" h	(216mm w x 203mm l x 29mm h)
OM 81-0200	8 1/2" w x 9" l x 1 1/8" h	(216mm w x 229mm l x 29mm h)
OM 81-0205	8 1/2" w x 12 1/2" l x 1 1/8" h	(216mm w x 318mm l x 29mm h)
OM 81-0210	8 1/2" w x 14 3/4" l x 1 1/8" h	(216mm w x 375mm l x 29mm h)
OM 81-0215	10 1/2" w x 6" l x 1 1/8" h	(267mm w x 152mm l x 29mm h)
OM 81-0220	10 1/2" w x 10" l x 1 1/8" h	(267mm w x 254mm l x 29mm h)
OM 81-0225	10 1/2" w x 15" l x 1 1/8" h	(267mm w x 381mm l x 29mm h)
OM 81-0230	10 1/2" w x 20" l x 2 1/2" h	(267mm w x 508mm l x 64mm h)
OM 81-0235	10 1/2" w x 20" l x 1 1/8" h	(267mm w x 508mm l x 29mm h)

Note: Customization of trays and additional sizes are available upon request.

STERILIZATION TRAYS

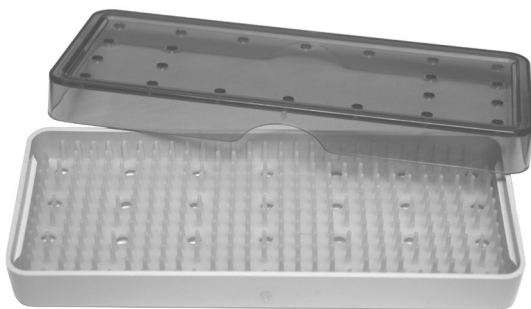

These trays are rugged enough to last for many years, yet gentle on delicate instruments. They cool down in 60 seconds after flash sterilization. Lightweight too! Sterilize and transport tools safely and easily. Convenient see-through lid allows you to inventory contents. FDA-approved soft mats come with each tray to prevent shifting of instruments. Mats retain their flexibility even after repeated sterilization at high temperatures. All trays withstand harsh rigors of steam autoclave, dry heat, or flash up to 320°F, 160°C, Eto, gas plasma, gamma radiation, hydrogen peroxide, cold sterilants, disinfectants, or germicides.

UNIVERSAL STERILIZATION TRAYS

OM 81-0290	3" w x 6" h shallow tray	2 1/2" w x 5 7/8" l x 3/4" h	(64mm w X 149mm l X 19mm h)
OM 81-0295	4" w x 8" h shallow tray	4" w x 7 1/2" l x 3/4" h	(102mm w X 191mm l X 19mm h)
OM 81-0300	7" w x 11" h deep tray	6 1/4" w x 10 1/2" l x 1 1/4" h	(159mm w X 267mm l X 32mm h)
OM 81-0305	11" w x 14" h shallow tray	11" w x 15" l x 3/4" h	(279mm w X 381mm l X 19mm h)
OM 81-0310	micro tray, base, lid, mat	2 1/2" w x 6" l x 1 1/4" h	(64mm w X 152mm l X 32mm h)
OM 81-0315	micro tray, base, lid, mat	2 1/2" w x 7 1/2" l x 3/4" h	(64mm w X 191 mm l X 19mm h)
OM 81-0320	micro tray, base, lid, mat	4" w x 6 1/2" l x 3/4" h	(102mm w X 165mm l X 19mm h)
OM 81-0325	micro tray, base, lid, mat	4" w x 7 1/2" l x 1 1/2" h	(102mm w X 191 mm l X 38mm h)
OM 81-0330	micro tray, base, lid, mat	6" w x 10" l x 3/4" h	(192mm w X 254mm l X 19mm h)
OM 81-0335	micro tray, base (deep), lid, mat	6" w x 10" l x 1 1/2" h	(152mm w X 254mm l X 38mm h)

Offers great protection for delicate scopes. Removable silicone bars fit any scope from 1mm to 10mm in diameter. All trays include base, lid, and mat.

These scope trays are designed to accommodate a variety of shapes and sizes. Safe for all standard sterilization methods including autoclave, steam, dry heat, and chemical. See-through lids offer easy identification. Silicone bars provide secure placement of scopes; the unique grid system allows versatility in scope placement and holds various sizes in one tray.

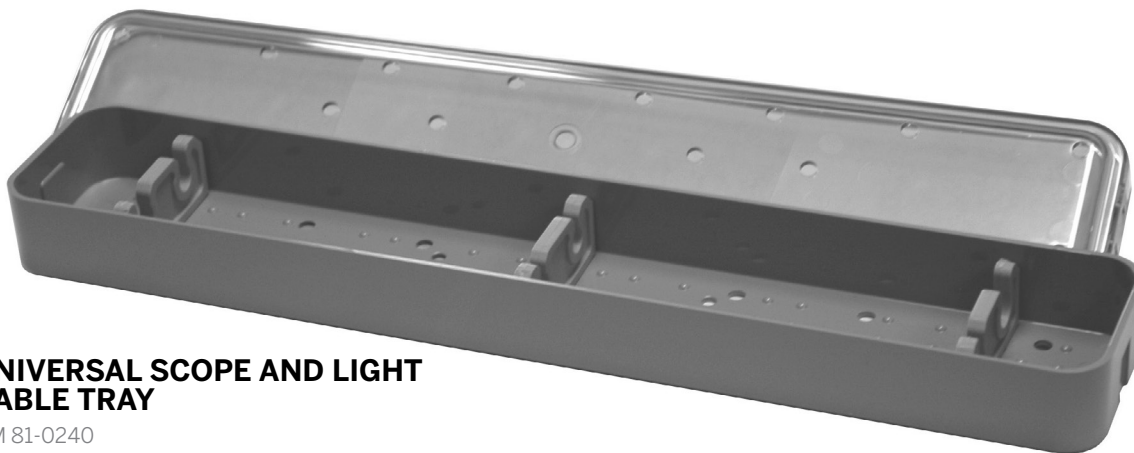

UNIVERSAL SCOPE AND LIGHT CABLE TRAY

OM 81-0240

Accommodates up to three 5mm to 10mm diameter scopes and a fiber-optic cable in one convenient tray. 8 1/4" w x 18 1/4" l x 2" h (210mm w x 464mm l x 51mm h). Includes base, lid, and bars.

SINGLE AND DOUBLE SCOPE TRAYS

OM 81-0245	single scope, med.	2 3/5" w x 16" l x 1" h	(66mm w x 406mm l x 25mm h)
OM 81-0250	double scope, med.	2 3/5" w x 16" l x 1" h	(66mm w x 406mm l x 25mm h)
OM 81-0255	cystoscope tray	3" w x 16 1/4" l x 1 1/2" h	(76mm w x 413mm l x 38mm h)
OM 81-0260	scope tray, base, lid	2 3/5" w x 16" l x 1 1/2" h	(66mm w x 406mm l x 38mm h)
OM 81-0265	scope tray, base, lid, mat	2 3/5" w x 16" l x 1 1/2" h	(66mm w x 406mm l x 38mm h)
OM 81-0270	scope tray, base, lid	6 1/2" w x 18" l x 1 1/2" h	(165mm w x 457mm l x 38mm h)
OM 81-0275	scope tray, base, lid, mat	6 1/2" w x 18" l x 1 1/2" h	(165mm w x 457mm l x 38mm h)
OM 81-0280	scope tray, base, lid	6 1/2" w x 18" l x 3" h	(165mm w x 457mm l x 76mm h)
OM 81-0285	scope tray, base, lid, mat	6 1/2" w x 18" l x 3" h	(165mm w x 457mm l x 76mm h)

Note: Customization of trays and additional sizes are available upon request.

Baskets, filters, mats, indicator labels are also available for each container.

Available with or without bottom perforated.

Lids available in blue, red, yellow, green, black and steel colors.



STERILIZING CONTAINER

		Length x Width x Depth
OM 83-0600	Full size	540mm x 280mm x 100mm
	Full size	540mm x 280mm x 135mm
	Full size	540mm x 280mm x 150mm
	Full size	540mm x 280mm x 260mm
OM 83-0700	3/4 size	465mm x 220mm x 100mm
	3/4 size	465mm x 220mm x 135mm
	3/4 size	465mm x 220mm x 150mm
	3/4 size	465mm x 220mm x 260mm
OM 83-0800	1/2 size	285mm x 280mm x 100mm
	1/2 size	285mm x 280mm x 135mm
	1/2 size	285mm x 280mm x 150mm
	1/2 size	285mm x 280mm x 260mm

Note: Customization of trays and additional sizes are available upon request.

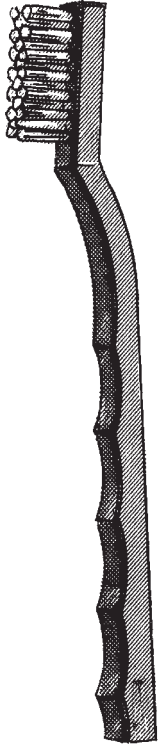

**INSTRUMENT
CLEANING BRUSH**

7" (178mm)
OM 39-0682
wire
set of three
OM 39-0684
nylon
set of three



**DOUBLE-SIDED BRUSH
FOR INSTRUMENT CLEANING**

OM 39-0686
Nylon/Wire



OLIVE TIP PLUNGER BRUSH

OM QA ST10-1.5 10" (254mm) 1.5mm tip
OM QA ST10-2.5 10" (254mm) 2.5mm tip
OM QA ST7-2-9-2mm 10" (254mm) 2mm tip
OM QA ST10-3.0 10" (254mm) 3.00mm tip



Specially designed for aspirator tips and saliva ejectors. More effective than the conventional pipe cleaner, the white bristles are stiff enough to clean blood and debris away from inside walls in one or two sweeps. The stainless steel wire prevents rusting on sinks and countertops after use. Made 12" (305mm) long, this brush will extend the full length of aspirator tips and is flexible enough to round 45 and 90 degree curvatures.

CLEANING BRUSHES

Set of 1 dozen
OM QA XSB X-small
OM QA SCB Small
OM QA MCB Medium
OM QA LCB Large
OM QA XLCB X-large

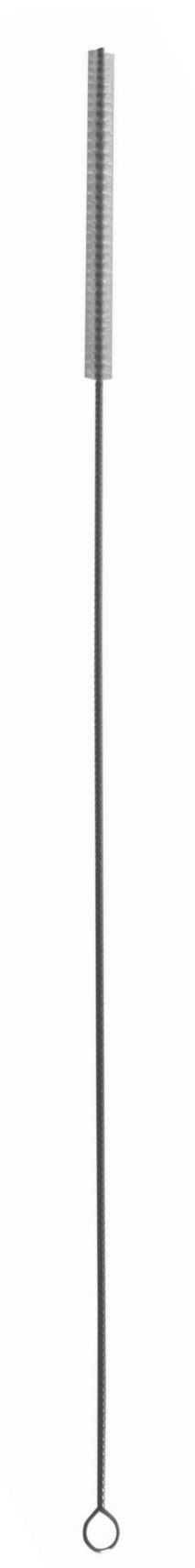

SPECIALTY CLEANING BRUSHES

	Qty. per Pkg.	Brush Diameter	Length of Bristle Area	End to End Length
OM BR-3050	2	.062 (1/16")	1/2"	6"
OM BR-3100	2	.062 (1/16")	1/2"	18"
OM BR-3110	2	.700	1/2"	18"
OM BR-3125	2	.700	1/2"	24"
OM BR-3113	2	.079	1/2"	6"
OM BR-3114	2	.079	3/4"	12"
OM BR-3115	2	.080	1"	24"
OM BR-3120	2	.087	1/2"	18"
OM BR-3130	2	.105	1"	18"
OM BR-3137	2	.118	2 3/4"	12"
OM BR-3140	2	.125 (1/8")	2"	18"
OM BR-3142	2	.144	3/4"	8"
OM BR-3143	2	.158	3/4"	8"
OM BR-3144	2	.197	3"	16"
OM BR-3145	2	.200	2"	24"
OM BR-3150	2	.250 (1/4")	2"	18"
OM BR-3153	2	.276	3"	16"
OM BR-3155	2	.312 (5/16")	3"	24"
OM BR-3170	3	.375 (3/8")	1 1/2"	6"
OM BR-3173	2	.393	3"	16"
OM BR-3175	2	.440 (7/16")	3"	24"
OM BR-3160	2	.880 (7/8")	3 1/2"	18"
OM BR-3165	2	.880 (7/8")	4 1/4"	24"
OM BR-2300 Stainless Steel Brush	2	.438	2"	6"
OM BR-4100 Nylon Bristles, Fan End	2	.500 (1/2")	3"	18"
OM BR-4140 Nylon Brush is Centered on Stainless Steel Wire	6	.500 (1/2")	3"	24"



Wide assortment of heavy-duty, seamless trays have covered corners for easy sterilization. Covers have recessed strap handles for ease in handling and storing.

INSTRUMENT TRAYS AND FLAT/SOLID COVERS

OM PW-43	5 3/8 x 4 x 2 5/8	12-5.0 lbs.
OM PW-43-2	Cover - fits 43 tray	12-3.5 lbs.
OM PW-63	6 1/8 x 6 1/8 x 2 7/8	12-7.3 lbs.
OM PW-63-2	Cover - fits 63 tray	12-5.1 lbs.
OM PW-952	8 7/8 x 5 x 2	12-7.3 lbs.
OM PW-953	8 7/8 x 5 x 3	12-8.6 lbs.
OM PW-952-2	Cover - fits above two trays	12-5.8 lbs.
OM PW-1002	10 x 6 1/2 x 2	12-10.3 lbs.
OM PW-1002-2	Cover - fits 1002 tray	12-11.3 lbs.
OM PW-1202	12 1/4 x 7 3/4 x 2 1/4	12-16.0 lbs.
OM PW-1202-2	Cover - fits 1202 tray	12-11.3 lbs.
OM PW-E1082	10 x 8 1/4 x 2 1/2	6-7.2 lbs.
OM PW-E1084	10 x 8 1/4 x 4	6-8.5 lbs.
OM PW-E1082-2	Cover - fits above two trays	6-6.7 lbs.
OM PW-E1650	16 1/2 x 10 x 2 1/2	6-12.5 lbs.
OM PW-E1654	16 1/2 x 10 x 4	4-9.7 lbs.
OM PW-1650-2	Cover - fits above two trays	6-9.3 lbs.
OM PW-E902	6 7/8 x 4 1/4 x 2	12-6.0 lbs.
OM PW-904	6 7/8 x 4 1/4 x 4	12-8.1 lbs.
OM PW-902-2	Cover - fits above two trays	12-2.9 lbs.
OM PW-E2302	13 7/8 x 12 7/8 x 2 1/2	6-14.3 lbs.
OM PW-E2304	13 7/8 x 12 7/8 x 4	6-17.3 lbs.
OM PW-E2306	13 7/8 x 12 7/8 x 6	6-20.4 lbs.
OM PW-2302-2	Cover - fits above three trays	6-10.9 lbs.
OM PW-E06062	6 7/8 x 6 3/8 x 2 1/2	6-3.2 lbs.
OM PW-E06064	6 7/8 x 6 3/8 x 4	6-5.0 lbs.
OM PW-E06066	6 7/8 x 6 3/8 x 6	6-6.6 lbs.
OM PW-602-2	Cover - fits above three trays	6-2.4 lbs.
OM PW-E10062	10 3/8 x 6 3/8 x 2 1/2	6-5.3 lbs.
OM PW-E10064	10 3/8 x 6 3/8 x 4	6-7.5 lbs.
OM PW-E10066	10 3/8 x 6 3/8 x 6	6-9.5 lbs.
OM PW-402-2	Cover - fits above three trays	6-3.4 lbs.



Covered corners and large, open head which allow for easy handling, stacking and cleaning.

OBLONG INSTRUMENT/DRYING TRAYS

OM PW-10F	w/rolled bead	10"l x 6 1/2"w x 3/4"h	(254mm l x 165mm w x 19mm h)	6-3.5 lbs.
OM PW-13F	w/rolled bead	13 11/16"l x 9 13/16"w x 3/4"h	(348mm l x 249mm w x 19mm h)	6-9.9 lbs.
OM PW-15F	w/rolled bead	15 1/8"l x 10 5/8"w x 3/4"h	(384mm l x 270mm w x 19mm h)	6-10 lbs.
OM PW-17F	w/rolled bead	17"l x 11 5/8"w x 3/4"h	(432mm l x 295mm w x 19mm h)	6-12.5 lbs.
OM PW-19F	w/rolled bead	19 1/8"l x 12 5/8"w x 3/4"h	(486mm l x 321mm w x 19mm h)	6-14.5 lbs.
OM PW-1520	w/rolled bead	21 1/4"l x 16 1/4"w x 7/8"h	(540mm l x 413mm w x 22mm h)	6-22.8 lbs.
OM PW-1525	w/flat flange	25"l x 15"w x 5/8"h	(635mm l x 381mm w x 16mm h)	6-24.5 lbs.
OM PW-E12101		12 3/4"l x 10 3/8"w x 1 1/4"h	(324mm l x 264mm w x 32mm h)	6-6.9 lbs.
OM PW-E20121		20 3/4"l x 12 3/4"w x 1 1/4"h	(527mm l x 324mm w x 32mm h)	6-14.9 lbs.



Stainless steel tray, 1/8" perforations in bottom, solid sides, safety handle hook on both ends for easy removal from the autoclave when hot.

FLASH TRAYS

With lid

OM 81-0340	5" x 7" x 2 1/2"	(127mm x 176mm x 64mm)
OM 81-0345	10" x 6 1/2" x 2 1/2"	(254mm x 165mm x 64mm)
OM 81-0350	10" x 10 1/2" x 3 1/2"	(254mm x 267mm x 89mm)

Without lid

OM 81-0355	5" x 7" x 2 1/2"	(127mm x 176mm x 64mm)
OM 81-0360	10" x 6 1/2" x 2 1/2"	(254mm x 165mm x 64mm)
OM 81-0365	10" x 10 1/2" x 3 1/2"	(254mm x 267mm x 89mm)

Tapered sides and rounded bead design make these basins ideal for storing and pouring.



MIXING/SOLUTION BOWLS

OM PW-12A	2/3 qt.	6 5/8 x 2 1/2	(168mm x 64mm)	12-5.3 lbs.
OM PW-18A	1 1/4 qt.	8 1/8 x 3	(206mm x 76mm)	12-7.2 lbs.
OM PW-22A	2 3/8 qt.	9 3/4 x 4	(248mm x 102mm)	12-10.8 lbs.
OM PW-26A	4 1/2 qt.	11 7/8 x 4 1/2	(302mm x 114mm)	12-14.0 lbs.
OM PW-30A	6 qt.	12 3/4 x 5 1/4	(324mm x 133mm)	6-9.1 lbs.
OM PW-32A	7 qt.	13 5/16 x 5 7/16	(338mm x 138mm)	6-10.0 lbs.
OM PW-40A	12 1/4 qt.	16 1/4 x 6	(413mm x 152mm)	6-14.0 lbs.



MEDICINE CUP - GRADUATED

OM PW-2 2oz. 2 1/8 x 2 (54mm x 51mm) 12-1.1 lbs.



IODINE CUP

OM PW-6G 6oz. 3 7/16 x 2 (87mm x 51mm) 24-3.5 lbs.
OM PW-14G 14oz. 4 3/8 x 2 5/8 (111mm x 67mm) 24-6.8 lbs.

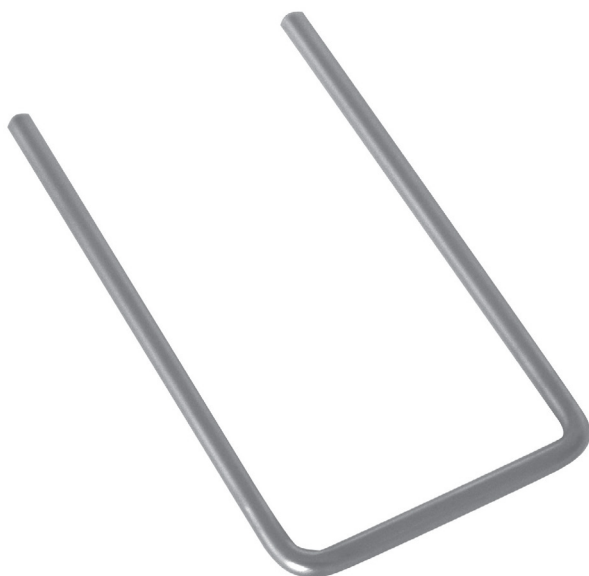

INSTRUMENT STRINGER OPEN END

OM 83-0010	6" x 2 1/2"	(152mm x 64mm)
OM 83-0015	6" x 3"	(152mm x 76mm)
OM 83-0020	8" x 2 1/2"	(203mm x 64mm)
OM 83-0025	10" x 2 1/2"	(254mm x 64mm)
OM 83-0030	12" x 2 1/2"	(305mm x 64mm)
OM 83-0035	14" x 2 1/2"	(356mm x 64mm)
OM 83-0040	6" x 2 1/2"	(406mm x 64mm)
OM 83-0045	18" x 2 1/2"	(457mm x 64mm)

Note:

- Instrument stringers hold ring handled instruments securely ensuring instruments stay opened during sterilization.
- Locking ball closure keep cross bar in place.
- Stay-closed design prevents accidental opening.
- Expertly hand finished to eliminate any sharp edges.
- Made from German stainless steel.
- To open or close: squeeze side bars together, and then move cross bar.

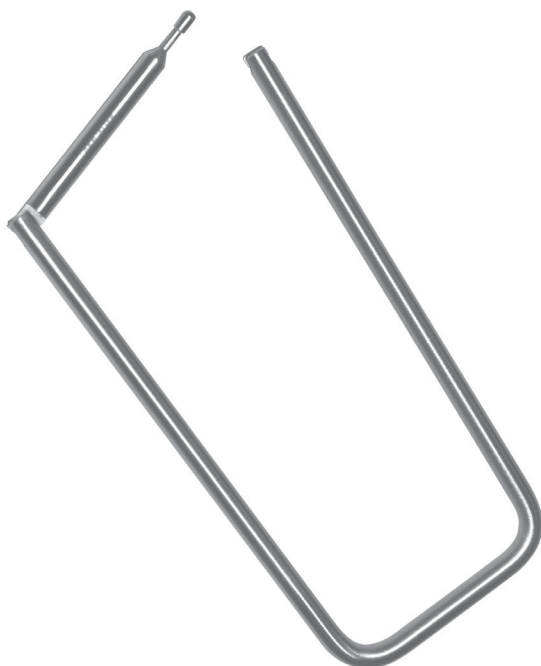

INSTRUMENT STRINGER CLOSED END

OM 83-0050	4" x 2 1/2"	(102mm x 64mm)
OM 83-0055	6" x 2 1/2"	(152mm x 64mm)
OM 83-0060	8" x 2 1/2"	(203mm x 64mm)
OM 83-0065	10" x 2 1/2"	(254mm x 64mm)
OM 83-0070	12" x 2 1/2"	(305mm x 64mm)
OM 83-0075	14" x 2 1/2"	(356mm x 64mm)
OM 83-0080	16" x 2 1/2"	(406mm x 64mm)
OM 83-0085	18" x 2 1/2"	(508mm x 64mm)



WEINSTEIN STERILIZING RACK

OM 83-0114	10"	(245mm)
OM 83-0116	12"	(305mm)
OM 83-0110	6"	(152mm)
OM 83-0112	8"	(203mm)

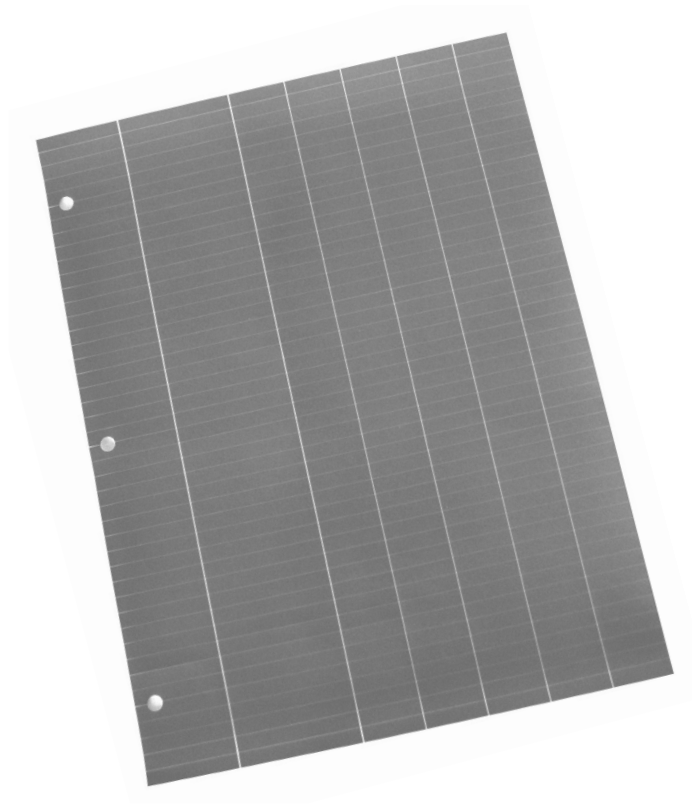

ID SHEET TAPE

Each 8 1/2" x 11" sheet contains 374" (9,500mm) of tape. Last through many autoclaving and gas sterilizing procedures.

Nine colors with white stripes.

OM 81-0100	Dark blue with white stripes
OM 81-0105	Dark green with white stripes
OM 81-0110	Red with white stripes
OM 81-0115	Yellow with white stripes
OM 81-0120	Orange with white stripes
OM 81-0125	Brown with white stripes
OM 81-0130	Lavender with white stripes
OM 81-0135	Light blue with white stripes
OM 81-0140	Pink with white stripes

INSTRUMENT IDENTIFICATION

Autoclavable. Each roll contains 300" (7,620mm) and are 1/4" (6mm) wide. Lasts through many autoclaving and gas sterilizing procedures.

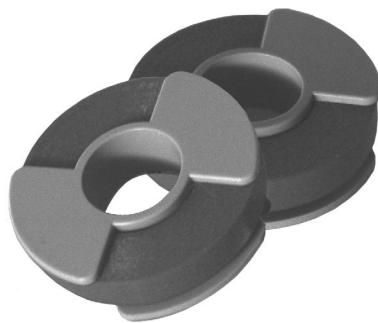

Available in ten colors.

OM 81-0145	White
OM 81-0150	Green
OM 81-0155	Yellow
OM 81-0160	Orange
OM 81-0165	Black
OM 81-0170	Purple
OM 81-0175	Blue
OM 81-0180	Red
OM 81-0185	Brown

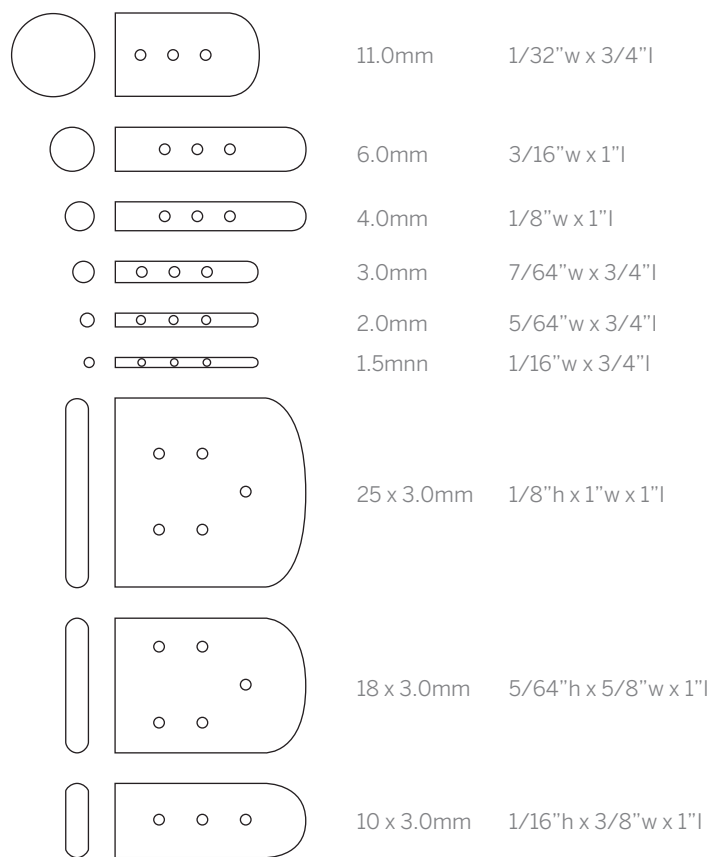

INSTRUMENT PROTECTORS NON-LATEX

Pack of 100

Steam permeable, autoclavable and stretch to fit a wide variety of instrument shapes and sizes.

Vented (shown)

OM 81-0010	11.0mm	1/32" w x 3/4" l	maroon
OM 81-0015	6.0mm	3/16" w x 1" l	yellow
OM 81-0020	4.0mm	1/8" w x 1" l	red
OM 81-0025	3.0mm	7/64" w x 3/4" l	green
OM 81-0030	2.0mm	5/64" w x 3/4" l	blue
OM 81-0035	1.5mm	1/16" w x 3/4" l	white
OM 81-0040	25 x 3.0mm	1/8" h x 1" w x 1" l	black
OM 81-0045	18 x 3.0mm	5/64" h x 5/8" w x 1" l	brown
OM 81-0050	10 x 3.0mm	1/16" h x 3/8" w x 1" l	orange

Non-vented

OM 81-0055	11.0mm	1/32" w x 3/4" l	maroon
OM 81-0060	6.0mm	3/16" w x 1" l	yellow
OM 81-0065	4.0mm	1/8" w x 1" l	red
OM 81-0070	3.0mm	7/64" w x 3/4" l	green
OM 81-0075	2.0mm	5/64" w x 3/4" l	blue
OM 81-0080	1.5mm	1/16" w x 3/4" l	white
OM 81-0085	25 x 3.0mm	1/8" h x 1" w x 1" l	black
OM 81-0090	18 x 3.0mm	5/64" h x 5/8" w x 1" l	brown
OM 81-0095	10 x 3.0mm	1/16" h x 3/8" w x 1" l	orange

Stainless steel fine mesh baskets are used for micro instruments washing, sterilization and storage.

- Top and lid frame wire diameter 3.5mm and 4.0mm (according to the size of the baskets)
- Fine mesh with opening square 1.6mm and wire diameter 0.7mm
- Wire locking clip
- Electrolyte polish

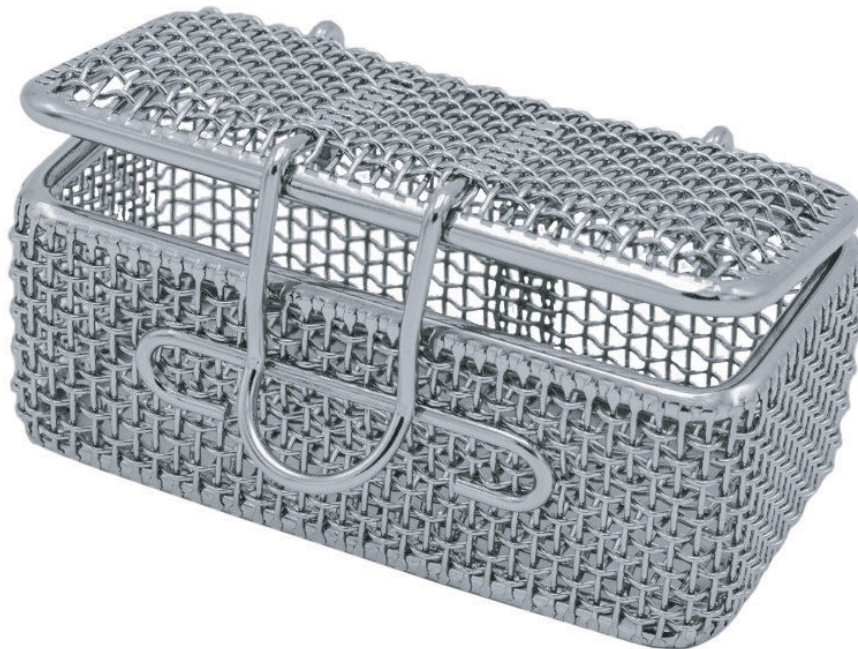

FINE MESH BASKETS

with locking clip

OM 83-0420	80mm x 40mm x 20mm
OM 83-0422	80mm x 40mm x 30mm
OM 83-0423	80mm x 80mm x 34mm
OM 83-0424	80mm x 80mm x 40mm
OM 83-0430	105mm x 70mm x 25mm
OM 83-0432	150mm x 50mm x 35mm
OM 83-0434	190mm x 85mm x 100mm
OM 83-0436	200mm x 100mm x 35mm
OM 83-0440	220mm x 140mm x 50mm
OM 83-0442	235mm x 155mm x 40mm
OM 83-0444	240mm x 90mm x 40mm
OM 83-0445	240mm x 120mm x 35mm
OM 83-0446	275mm x 175mm x 35mm
OM 83-0448	275mm x 200mm x 35mm



DEBRIDEMENT PAN

with mesh insert

OM 2008 21" (533mm) x 13" (330mm) x 3" (76mm)